

Built  
Bull  
Dog  
Tuff™



**Bull  
Dog  
Power  
Products®**



**1000-Watt Twin Head Contractor Grade Worklight**  
**Deux Projecteurs 1000 Watts Qualité Professionnelle**  
**Lámpara de Doble Foco de 1000 Vatios Para Contratista**

Model numbers: S10112, Model ST6; S10111, Model ST7

Numéros de modèle : S10112, Model ST6; S10111, Model ST7

Modelos número: S10112, Model ST6; S10111, Model ST7

**500-Watt Single Head Contractor Grade Worklight**  
**Projecteur de 500 Watts Qualité Professionnelle**  
**Lámpara Sencilla de 500 Vatios Para Contratista**

Model numbers: S10110, Model SS8

Numéros de modèle : S10110, Model SS8

Modelos número: S10110, Model SS8

**Warning: Read all instructions before operating or servicing this light.**

**Lire ces instructions avec soin avant toute opération de mise en marche et de réparation.**

**Lea atentamente las instrucciones antes de usar o dar mantenimiento a esta lámpara.**

## ASSEMBLY OF TRIPOD STAND

1. Place the legs of the Tripod Stand in a stable position as shown.

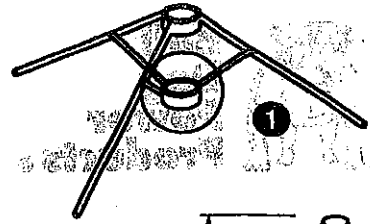

2. Remove the screw from the Tripod Stand as shown.

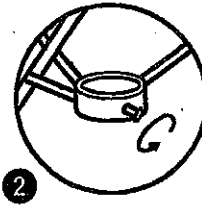

3. Extend inner pole of Extension Pole 6 inches by rotating locking collar counterclockwise. This will expose hole in bottom pole.

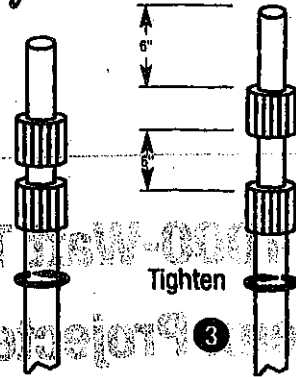

4. Insert Extension Pole through Tripod Stand as shown.

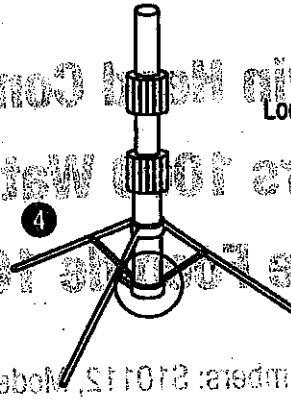

5. replace screw.

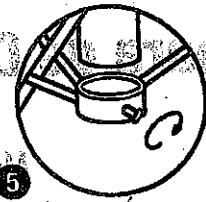

## ASSEMBLE CROSSBAR TO TRIPOD STAND

1. Insert small end of Pole Clamp through square hole in Crossbar.

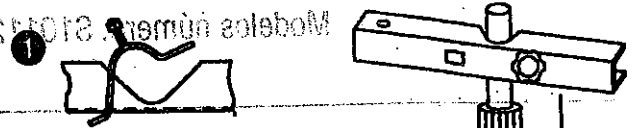

2. Insert Square Neck Bolt through Pole Clamp and Start Knob. DO NOT TIGHTEN.

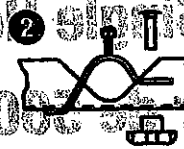

3. Slide assembled Crossbar over top pole of Tripod Stand. Top of pole should be approximately 1" above Crossbar. Tighten knob securely.

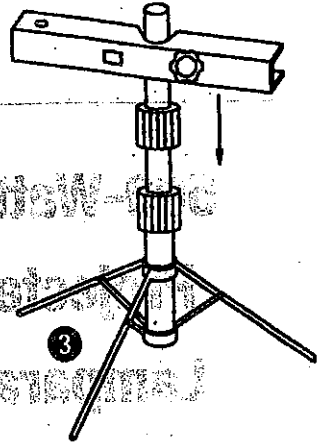

## INSTALL LAMPS IN FIXTURES

1. Remove screw from back of handle and set handle aside.

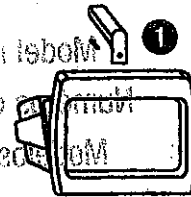

2. Open Lens Frame and install lamp by inserting one end of lamp into ceramic socket, then, pushing gently against inserted end, slide other end into place. (DO NOT touch lamp with bare hand. Use clean gloves or soft cloth. Oil from skin may damage lamp.)

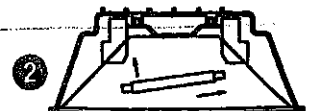

3. Insert one end of Grill Guard between the Lens Frame and glass. Gently squeeze and insert other end.

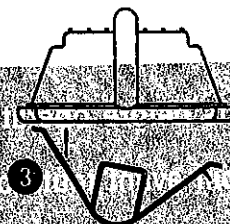

4. Close Lens Frame and install handle in upright position. Insert screw through handle and tighten.

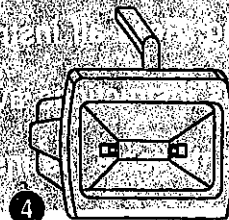

## ASSEMBLE LIGHT HEADS TO CROSSBAR

1. Align hole in **Light Mounting Bracket** with hole in **Crossbar**.

2. Assemble bolt, washers, rubber bushing and nut in order shown.

3. **DO NOT** overtighten nut. Light fixture should rotate smoothly.

4. Mount **Junction Box** on the stud protruding from the **Pole Clamp**.

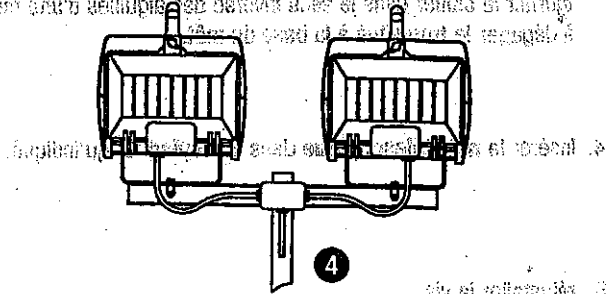
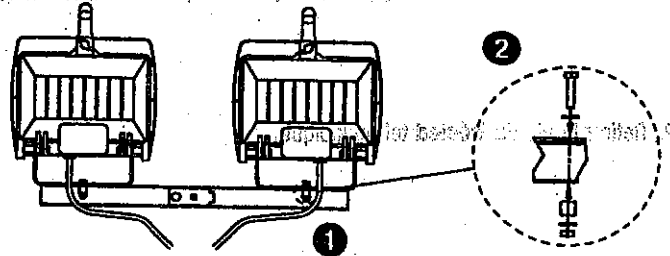

## SAFETY INSTRUCTIONS

**CAUTION:** Failure to comply with these instructions could result in personal injury, death or property damage. This product was designed for normal open-air use.

**WARNING:** When using outdoor portable lamps, basic safety precautions should always be followed to reduce the risk of fire, electric shock or personal injury.

### NOT INTENDED FOR USE IN POTENTIALLY EXPLOSIVE ATMOSPHERES!

1. **Lighted lamp is hot!** To avoid risks of burns or injury, be certain that the power is off and the bulb is fully cooled before replacing.
2. The light fixture and telescopic pole will conduct electricity. **Use extreme caution to avoid contact with electric wiring and foreign objects.**
3. Under wet or damp conditions, use a ground fault interrupter circuit. (GFI)
4. **Never touch the bulb with bare hands.** The contaminated bulb will have reduced life and may shatter at high temperatures. Use clean gloves or cloth to hold the bulb during installation.
5. Halogen bulbs operate under high pressure and may shatter. **protective lens must be in place at all times.**
6. Plug into standard AC (Alternating Current) outlet only. Use only outdoor extension cords that have a three-prong grounding plug.
7. Do not use with extension cord near water or where water may accumulate. Do not submerge.
8. Keep lamp at least 16 feet away from pools or spas.
9. Keep away from curtains, draperies and flammable materials.
10. Disconnect power and let unit cool down before changing a bulb or performing any maintenance on this product.
11. All worn or frayed cords must be replaced immediately.
12. When using in windy conditions, support legs with sandbags.
13. Use only bulbs rated for this fixture.
14. **Do not look directly into lighted bulb.**
15. Keep fixture away from children.

**NOTE:** Run cord through leg ring to prevent the light from tipping.

## SAVE THESE INSTRUCTIONS

### ONE-YEAR LIMITED WARRANTY

Warner Manufacturing Company warrants this light against all manufacturing defects in material or workmanship that occur under normal use for a period of one year from the date of original purchase. At the Company's option we will repair or replace any defective parts, except bulbs, without charge for either parts or labor for this one-year period. The customer must provide proof of original purchase and is responsible for freight to our facility.